

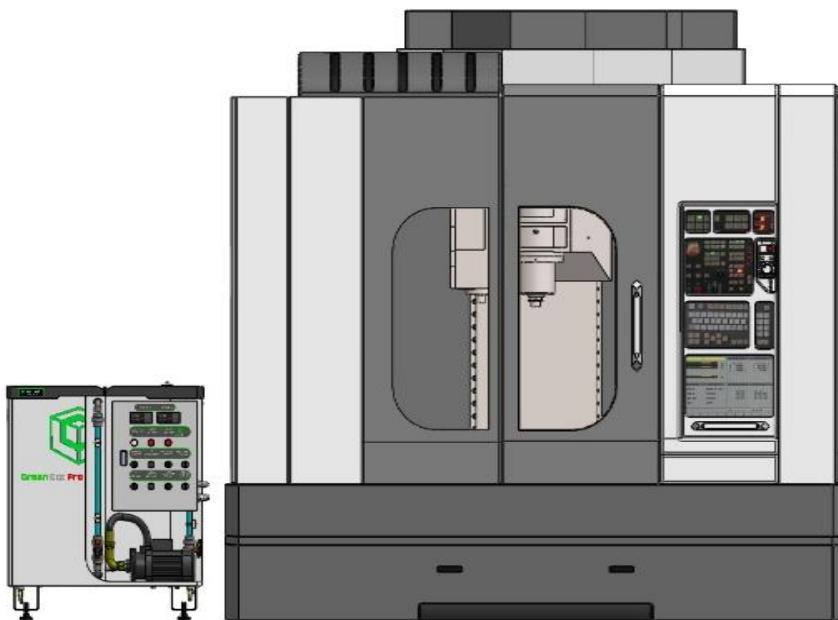

## Auto Filtration systems FCG-105 AUTO

### INSTRUCTION MANUAL

(Original Instructions)



瑞亞精密股份有限公司 TEL: +8864 25359633

[www.greenecopro.com.tw](http://www.greenecopro.com.tw)

42755 台中市崇德路四段 183 巷 12-19 號



## Dimension & Carton

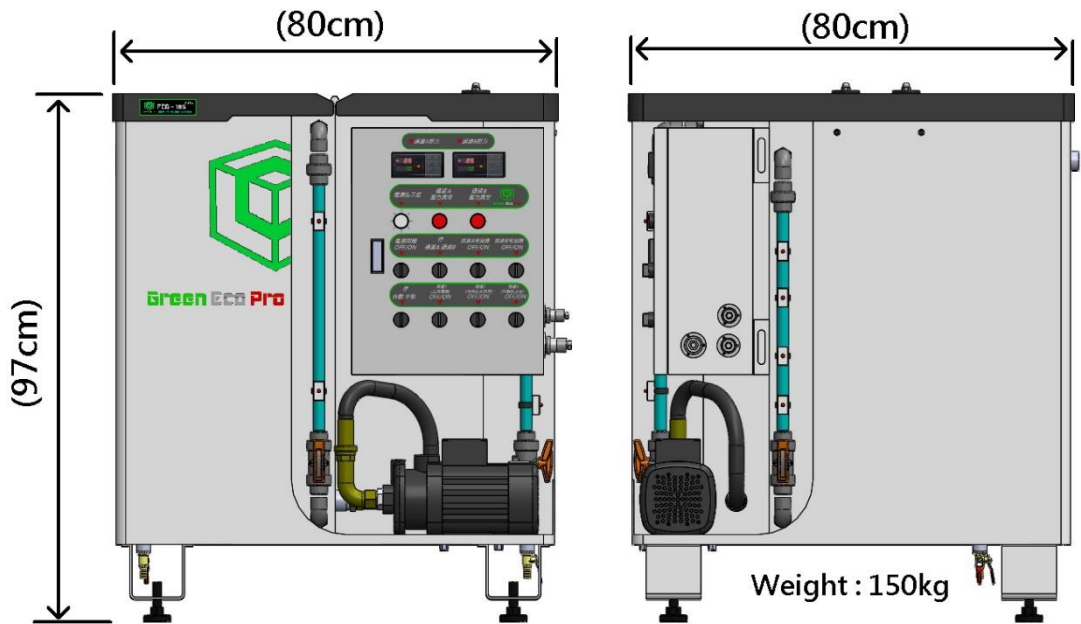



## Description of each part

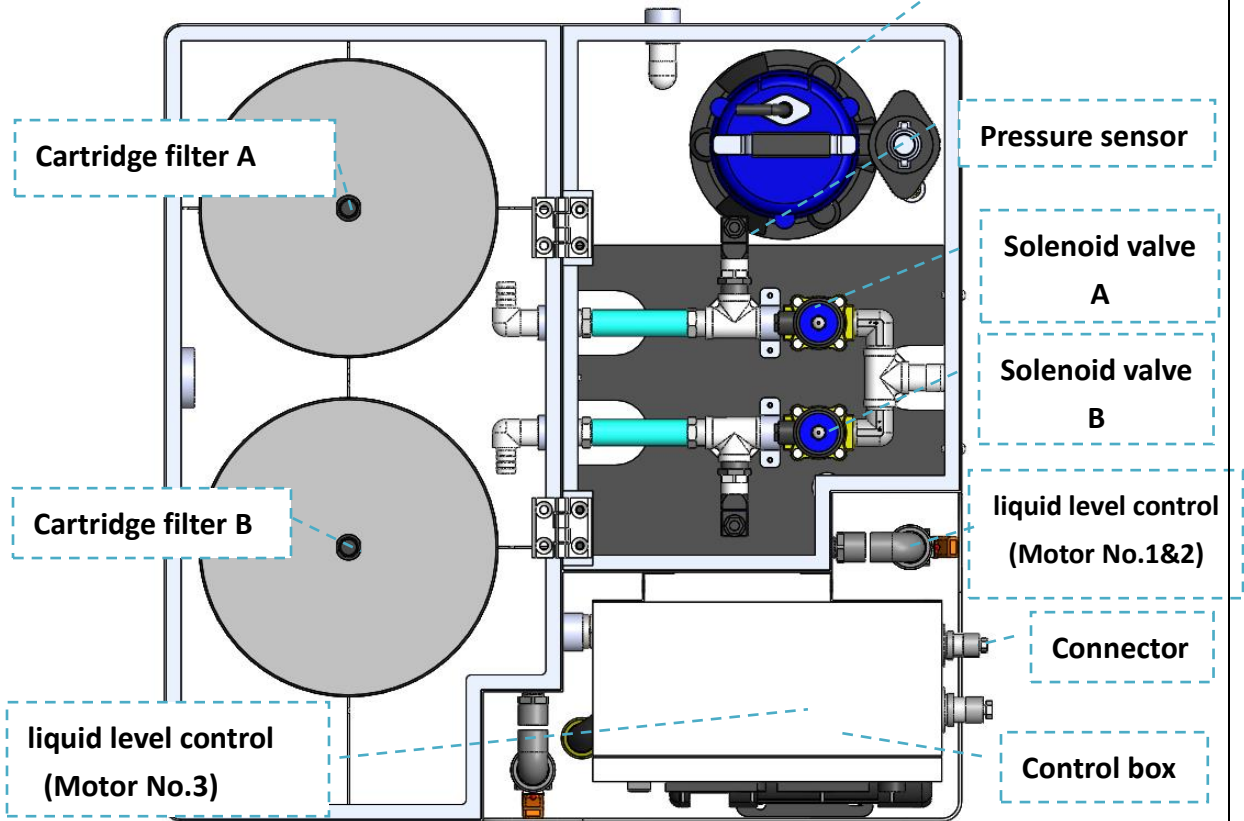
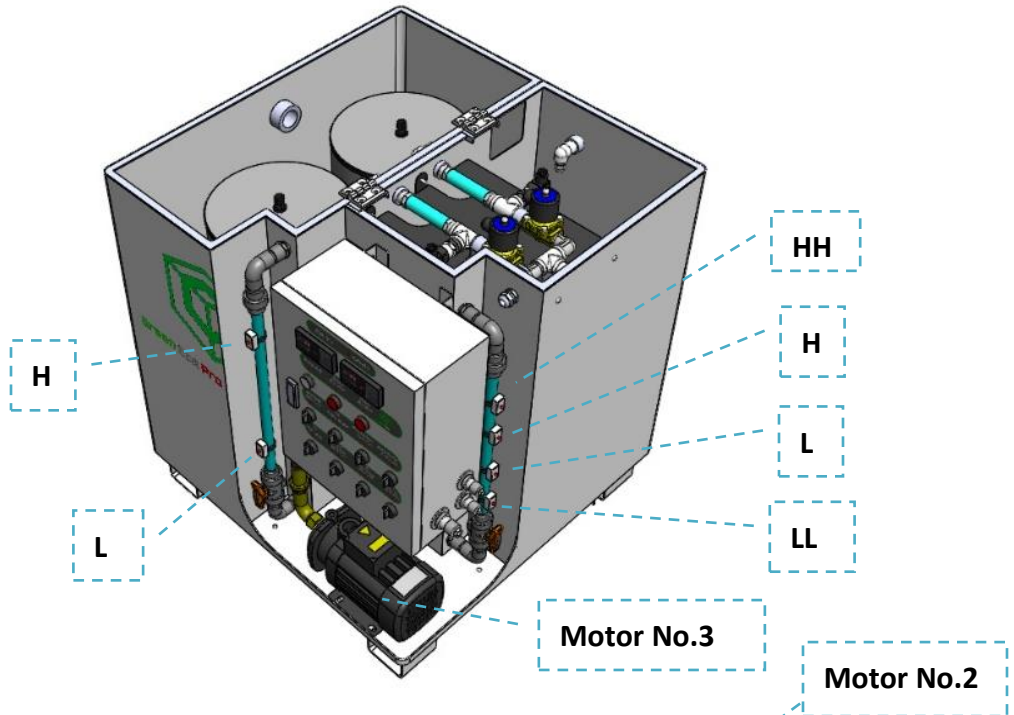



## Operation Button



## Action Process

FCG-105 Auto which User can select Auto system or Manual system ; FCF-105 Auto is separated to Trough A and Trough B. The waste liquid flow into Trough A and then flow into Trough B for purifying the liquid for reusing by CNC machine.

Sep up : Motor No.1 : pump from CNC (Image graphic)

Motor No. 2 : Pump inner barrel in Trough A

Motor No. 3 : Land type motor in Trough B

Absorb the waste coolant from water tank of CNC and filter waste coolant out Trough A and then filter coolant out Trough B second time by No.2 motor. The motor No.3 is controlled by CNC machine.

The motors are controlled and protected by a liquid level sensor.

Motor 1 — HH - Stop ; LL – Operate (H- ON)

Motor 2 — H - Operate ; L - Stop

Motor 3 — H - Operate ; L - Stop (Defensive mechanisms , controlled by CNC interface)

### Operation :

When equipment is adjusted by Automatic, the filter of system will already reach saturation value (1KG/CM3), the light will be flash and change filter A to filter B.

### Reset :

filter A is saturation and will change filter B by Auto, but the LED will keep on flash to notice user for clean filter A.

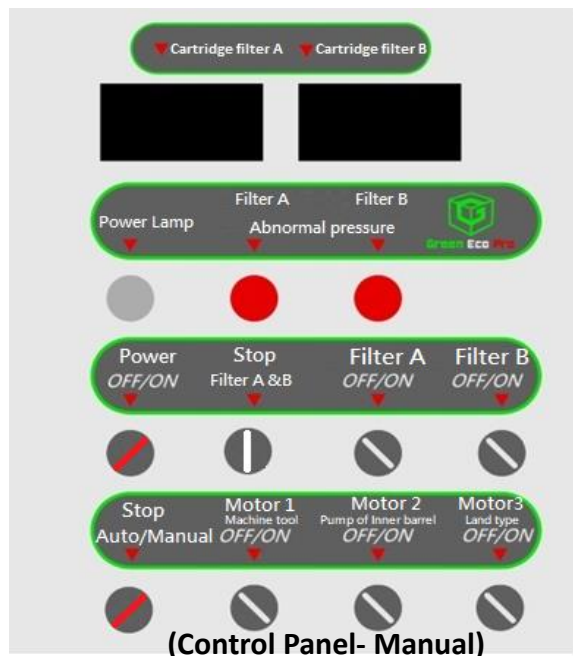
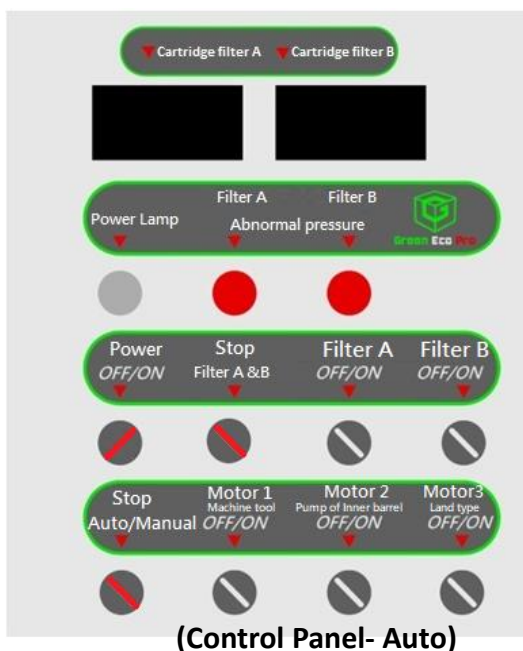

## Function Description

FCG-105 Auto is Automatic system machine, the material of filter basket adopts three layers of special materials and filter Precision reach  $5 \mu\text{m}$ , flow flux reach 110 LPM. It is effective filter material to defer saturation.

Scope of application : Spark machining 、 Full oil process 、 Grinding etc. For high precision, the FCG-105 intercept the tiny particle and the filter tube is consumable for replace regular.

Filter Effective Chart

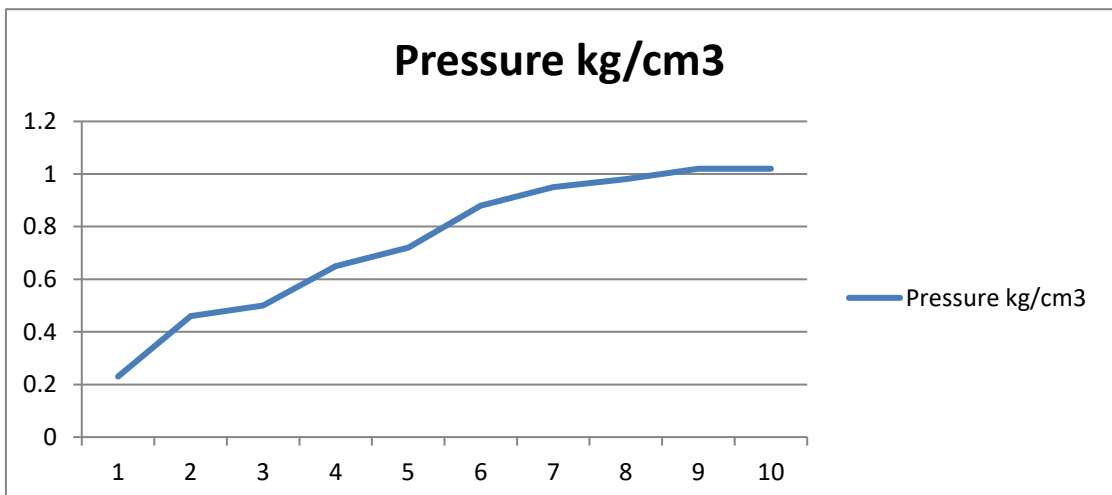
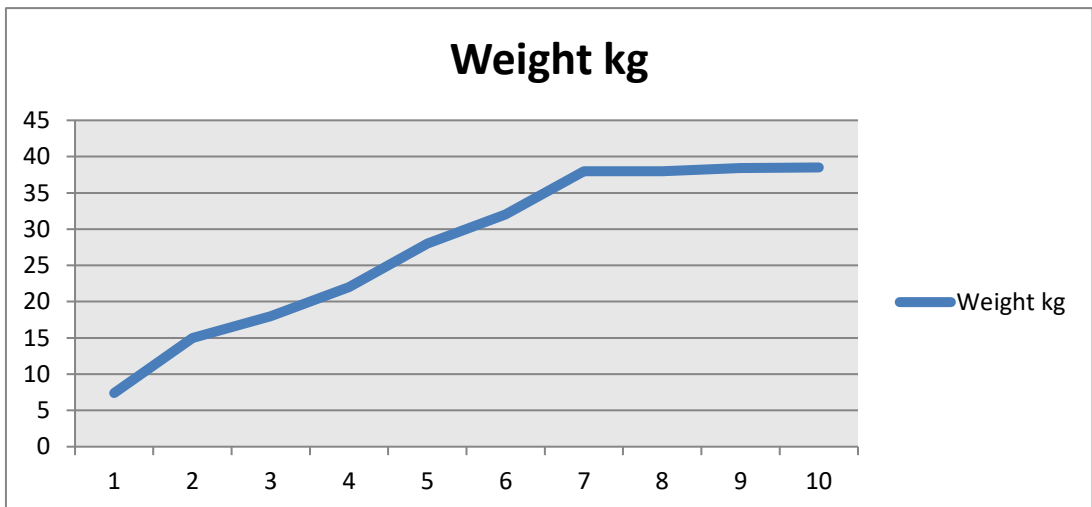



Model	FCG-105 AUTO	Unit
Dimension	800 X800 X970	mm
Voltage	110/220	V
Submerged pump	1/2 hp	Japanese customize motor
Precision filter tube	V	
Alarm lamp	V	
water pump	V	
Pressurized motor	V	
control panel	V	

# WARRANTY

<b>Model</b>	<b>FCG-105 AUTO</b>
<b>Manufacture date</b>	
<b>Serial number</b>	

The warranty offered on these products provides coverage against defective parts or faulty workmanship subjected to all routine maintenance and run up procedures being observed and carried out within these periods as detailed by Green Eco Pro Co.

The warranty does not cover for replacements in the event of accidental such as natural disasters or malicious damage or damage caused by misuse of the product.

If the warranty is not stamped by the company's or dealer's or has been altered, the warranty is invalid.

**Do not apply any chemical products or water with a temperature that exceeds 60 degrees.**